



Nissan Intelligent Mobility moves you one step ahead. In cars that feel like an extension of you, helping you see more and sense more, reacting with you, and sometimes even for you. Nissan Intelligent Mobility is about a better future – moving through life with greater confidence, excitement and connection to the world around you.



TITAN®  
TITAN XD®  
2022



2022 TITAN®. EPA data not available at time of publication. Targeted 2022 fuel economy 16 City MPG / 21 Highway MPG / 18 Combined MPG for TITAN® S, SV, Platinum Reserve 4x2; 15 City MPG / 21 Highway MPG / 18 Combined MPG for TITAN S, SV, Platinum Reserve 4x4; 15 City MPG / 20 Highway MPG / 17 Combined MPG for TITAN PRO-4X®. MPG estimate based on Nissan internal testing results, subject to EPA confirmation. Actual mileage may vary with driving conditions. Use for comparison only. <sup>54</sup>Roadside assistance coverage period varies by model-year model. For complete information concerning warranty coverage, conditions and exclusions, see your Nissan dealer and read the warranty information booklet for the model-year model. Apple CarPlay® is a registered trademark of Apple, Inc. Apple Music® is a registered trademark of Apple, Inc. Google, Android, Android Auto, Google Maps and other marks are trademarks of Google LLC. To use Android Auto on your car display, you'll need an Android phone running Android 6 or higher, an active data plan, and the Android Auto app. Bilstein® is a registered trademark of ThyssenKrupp Bilstein GmbH. Bluetooth® word mark and logos are owned by Bluetooth SIG, Inc. Facebook® is a registered trademark of Facebook, Inc. Fender® is a registered trademark of Fender Musical Instruments. HomeLink® is a registered trademark of Gentex Corporation. iPhone® is a registered trademark of Apple, Inc. All rights reserved. iPhone® or other external device not included. KICKER® is a registered trademark of Stillwater Designs. Siri® and Siri® Eyes Free are registered trademarks of Apple, Inc. The Sirius®, XM®, and SiriusXM® names and all related marks and logos are trademarks of Sirius XM Radio Inc. Twitter® is a registered trademark of Twitter, Inc. Yakima® is a registered trademark of Yakima Products, Inc. This brochure is intended for general descriptive and informational purposes only. It is subject to change and does not constitute an offer, representation or warranty (express or implied) by Nissan North America, Inc. Interested parties should confirm the accuracy of any information in this brochure as it relates to a vehicle directly with Nissan North America, Inc., before relying on it to make a purchase decision. Nissan North America, Inc., reserves the right to make changes, at any time, without prior notice, in prices, colors, materials, equipment, specifications, and models and to discontinue models or equipment. Due to continuous product development and other pre- and post-production factors, actual vehicle, materials and specifications may vary from this brochure. Some vehicles shown with optional equipment. See the actual vehicle for complete accuracy. Availability and delivery times for particular models or equipment may vary. Specifications, options and accessories may differ in Hawaii, U.S. territories and other countries. For additional information on availability, options or accessories, see your Nissan dealer or contact Nissan North America, Inc. At [NissanUSA.com](http://NissanUSA.com), you'll find virtual product demonstrations, a way to "build your own Nissan," a dealer locator, and more information about key Nissan support services. Or if you'd prefer, call 1-800-NISSAN-3 for answers to specific questions about TITAN®/TITAN XD® or any other Nissan vehicle. The Nissan names, logos, product names, feature names, and slogans are trademarks owned by or licensed to Nissan Motor Co. Ltd. and/or its North American subsidiaries. Other trademarks and trade names are those of their respective owners. **Always wear your seat belt, and please drive responsibly.** '22 TITAN® 2201110-N-12/21-60K-KSL



TITAN®  
Crew Cab PRO-4X®

TITAN XD®  
Crew Cab S

TITAN  
King Cab® SV

TITAN XD  
Crew Cab PRO-4X

TITAN  
Crew Cab Platinum Reserve

America's Best Truck Warranty  
**5 YEARS/100,000 MILES**  
BUMPER-TO-BUMPER WARRANTY<sup>1</sup>

TITAN  
See dealer for limited warranty details.

Best-in-Class Standard  
Horsepower (excluding EVs)<sup>2</sup>  
400-Horsepower Endurance® V8<sup>3</sup>

Most Standard Safety  
Technology in its Class  
(excluding EVs)<sup>4</sup>

Most Standard  
Technology in its Class  
(excluding EVs)<sup>5</sup>

## Work as hard as you play

The 2022 TITAN and TITAN XD bring more high-tech muscle to your jobsites, projects, and adventures. Tow up to 11,060 lbs.<sup>6,7,8</sup> (TITAN XD with gooseneck hitch) with more confidence. Feel the strength of class-leading standard horsepower (excluding EVs).<sup>2</sup> Do it all with the confidence of standard Nissan Safety Shield® 360 features.<sup>9</sup> This is the truck you've been waiting for.



NISSAN  
INTELLIGENT  
MOBILITY™



Rear Automatic Braking<sup>12</sup>

### Standard Nissan Safety Shield® 360

Nissan Intelligent Mobility is changing how you move forever with technology that makes you feel more connected, confident, and excited. As part of Nissan Intelligent Mobility, Nissan Safety Shield 360 includes features that help you see more, sense more, and can give you an assist when you need it. The following Safety Shield 360 features are standard on all 2022 TITAN® and TITAN XD® models.<sup>9,10</sup>

- |   |                                      |  |
|---|--------------------------------------|--|
| Automatic Emergency Braking with Pedestrian Detection <sup>11</sup> | Rear Automatic Braking <sup>12</sup> | Rear Cross Traffic Alert <sup>13</sup> |
| Blind Spot Warning <sup>14</sup>                                    | Lane Departure Warning <sup>15</sup> | High Beam Assist                       |



Intelligent Cruise Control<sup>17,20</sup>



Lane Departure Warning<sup>15</sup>

### A cabin without compromise

It's easy to feel taken care of in the TITAN and TITAN XD. You can have the latest smartphone connectivity,<sup>16</sup> a Fender® audio system,<sup>17</sup> and even a Wi-Fi Hotspot.<sup>17,18</sup> There are also available comforts like front Zero Gravity seats<sup>19</sup> and climate-controlled front seats,<sup>17</sup> plus a clever holder for two smartphones or a tablet.<sup>17</sup> And with the Dual Panel Panoramic Moonroof,<sup>17</sup> this truck just might spoil you rotten.



Fender  
PREMIUM AUDIO



### Supercharge your connectivity

**Apple CarPlay® integration** People to see? Places to be? Just ask Siri.® Equipped with Siri® voice control, Apple CarPlay® (shown on left) brings your contacts, favorite messaging apps, Apple Music® playlists, Apple Maps, and more on board to your TITAN or TITAN XD. Simply plug in your compatible iPhone® and go.<sup>16, 18, 21, 22</sup>



**Android Auto™** Talk to Google on Android Auto and get things done with your voice. Easily send messages, get directions, control media and more. Just say, "Hey Google" or, in compatible vehicles, long-press the voice control button on your steering wheel to get started.<sup>16, 18, 21, 22</sup>







### A truck's-eye view

This is your Integrated Command Center. Gaze into the super-size 9" color touch-screen, and line up a trailer with ease using the Intelligent Around View® Monitor. And with the system's virtual composite 360° bird's-eye view, you've got enhanced visibility to help you maneuver — even in tight spots. It also gives you an on-screen alert when it detects moving objects near your vehicle.<sup>17, 23, 24, 25</sup>

### Towing made easy

The innovative Trailer Light Check makes it easier to tow — even when you're going solo. Once you've hooked up your trailer, you can easily check all brake light connections by cycling through the lights with your Nissan Intelligent Key®. No muss, no fuss, no help needed.<sup>17, 25</sup>



### A smarter, tougher truck bed

TITAN® and TITAN XD® are ready to tackle the tough jobs. TITAN's truck bed is smart, strong, and capable, with features like a spray-on bedliner,<sup>17</sup> Utili-track® multi-channel system,<sup>17, 26</sup> 120-volt in-bed power outlet,<sup>27</sup> and bright LED bed lighting.<sup>17</sup>

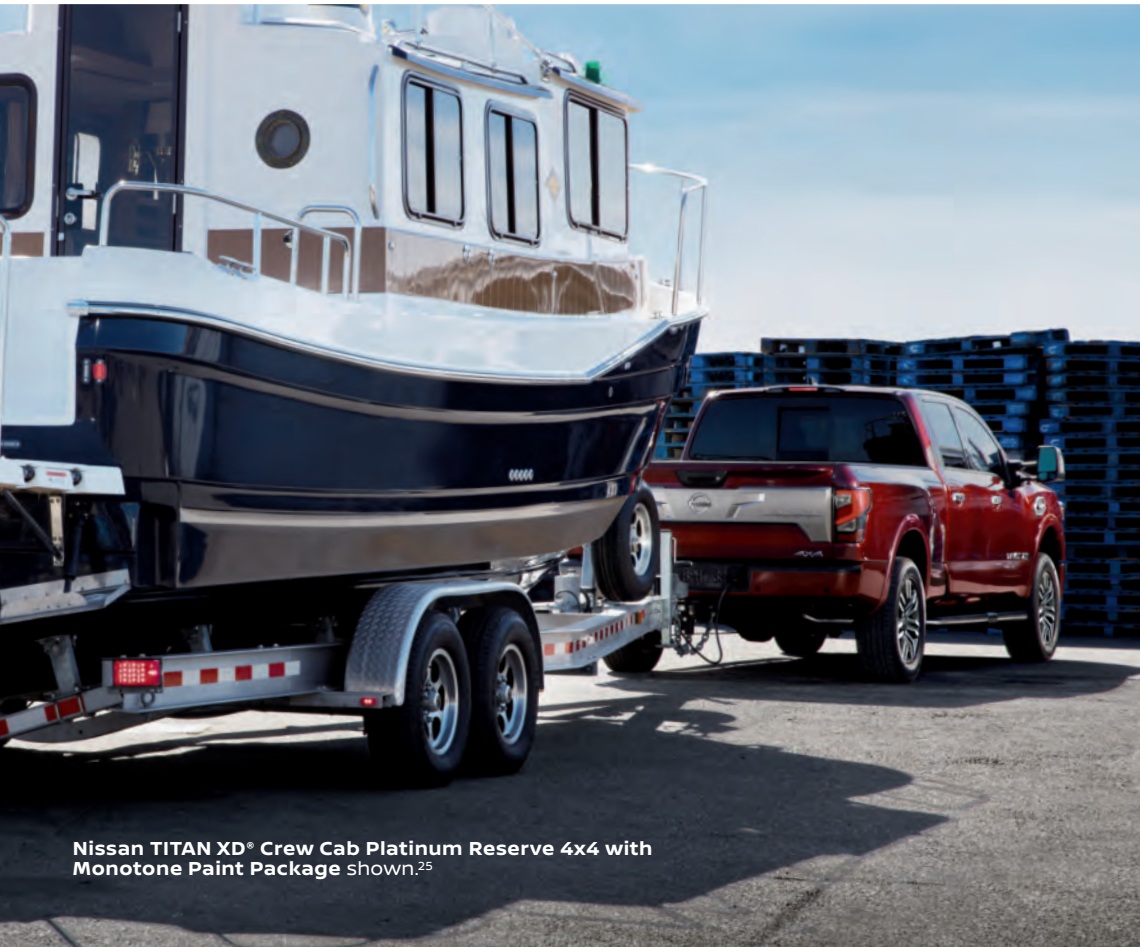

Nissan TITAN XD® Crew Cab Platinum Reserve 4x4 with Monotone Paint Package shown.<sup>25</sup>



Nissan TITAN® Crew Cab PRO-4X® with Utility, Convenience and Moonroof Packages shown.<sup>26</sup>

### Available bed lengths

TITAN King Cab®

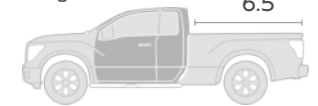

TITAN Crew Cab

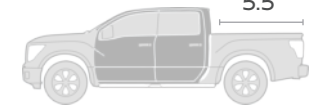

TITAN XD Crew Cab



### Available in your size

To make sure you have the right equipment for the job, TITAN and TITAN XD give you the flexibility the job requires with two available bed lengths, depending on cab configuration.<sup>26</sup>





### Off-road obsessed

PRO-4X® takes advantage of advanced technology to tackle many challenging conditions. A 7" high-resolution Advanced Drive-Assist Display includes a dedicated off-road display as well as a Tire Pressure Monitoring System.<sup>28, 29</sup> The Intelligent Around View® Monitor is a game changer, helping you rock crawl and avoid obstacles you might not otherwise see.<sup>17, 23</sup>

- 18" All-terrain Tires
- Electronic Locking Rear Differential
- Bilstein® Off-road Performance Shocks



### Bold PRO-4X style

The 2022 PRO-4X stands further out from the crowd – with unique bold accents and an aggressive style, it shows it's ready to tackle many challenging conditions. You'll see the unique PRO-4X insignia all over the exterior, and the interior is a style knockout too, with embroidered logos, contrasting stitching, and metallic-tone accent trim.



### Extra armor

Designed by off-roaders, for off-roaders, the PRO-4X comes equipped with 18" all-terrain tires, an electronic locking rear differential, Bilstein® off-road performance shocks, and skid plates to protect the lower radiator, transfer case, transmission, fuel tank, and oil pan.<sup>30</sup>





Nissan TITAN® Crew Cab PRO-4X® 4x4 shown.<sup>25</sup>

### TITAN XD

#### Tow like a pro

TITAN XD's integrated Gooseneck Hitch and 7-pin in-bed wiring harness give you more ways to tow. Engineered directly into the frame, the hitch is ready to handle the big loads.<sup>8,17</sup> And when not in use, the ball is removable and stores in a convenient available storage bag.



### TITAN® / TITAN XD®

A standard V8 that sets the standard

The potent Endurance® V8 gas engine features Direct Injection, a 4-valve-per-cylinder design, and Variable Valve Event and Lift (VVEL™) technology for power, efficiency, and refinement you can feel.

# 400

HORSEPOWER<sup>3</sup>

# 413

LB-FT OF TORQUE<sup>3</sup>



Nissan TITAN XD® Crew Cab Platinum Reserve 4x4 shown.<sup>8</sup>



# TITAN<sup>®</sup> Horsepower backed by a strong foundation

The TITAN of trucks is built to work, and work hard. You've got a best-in-class standard 400-horsepower V8,<sup>2,3</sup> a 9-speed transmission, and 4-wheel ventilated disc brakes. Underneath, TITAN has a reinforced frame and rugged components. Add in a bold look, an interior that would make a luxury sedan jealous, and advanced technology, and the TITAN is ready to take on just about whatever you need. And if you need even more hard-working performance – check out the TITAN XD.

400-hp<sup>3</sup>  
5.6-L Endurance<sup>®</sup> V8

Up to 9,310 lbs.<sup>7</sup>  
Maximum Towing  
Crew Cab (shown)

Up to 9,320 lbs.<sup>7</sup>  
Maximum Towing  
King Cab<sup>®</sup> (not shown<sup>31</sup>)

Up to 1,650 lbs.<sup>32</sup>  
Maximum Payload  
Crew Cab (shown)

Up to 1,710 lbs.<sup>32</sup>  
Maximum Payload  
King Cab (not shown<sup>33</sup>)

Crew Cab with 5.5' Bed  
King Cab with 6.5' Bed

Reinforced, Fully Boxed, Full-length Ladder Frame

4-wheel Ventilated  
Disc Brakes

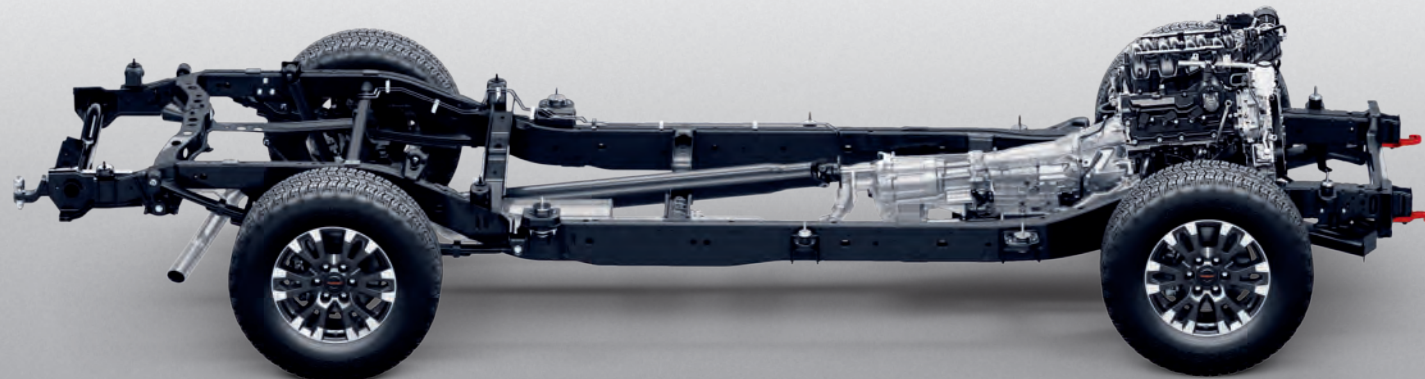

# TITAN XD<sup>®</sup> Hard-core capability

Just imagine what you can do with TITAN XD. It all starts with a solid core, and TITAN XD lays the groundwork with a larger full-length, fully boxed ladder frame, reinforced in key areas for incredible lateral rigidity. Add in a longer wheelbase and you'll get a foot more of bed length to work with than the TITAN Crew Cab. From there, we attach heavy-duty components that are built to last. It all adds up to strength, durability, and reliability you can count on for years to come.

NEED MORE?  
UPGRADE TO TITAN XD

Up to 10,920 lbs.<sup>6</sup>  
Maximum Towing

Up to 2,430 lbs.<sup>34</sup>  
Maximum Payload

14-inch  
Commercial-grade  
Disc Brakes

Crew Cab with 6.5' Bed

Up to 11,060 lbs. Maximum  
Towing with available  
gooseneck hitch<sup>8</sup>

 Larger Reinforced,  
Fully Boxed, Full-length  
Ladder Frame with  
Commercial-grade  
Components

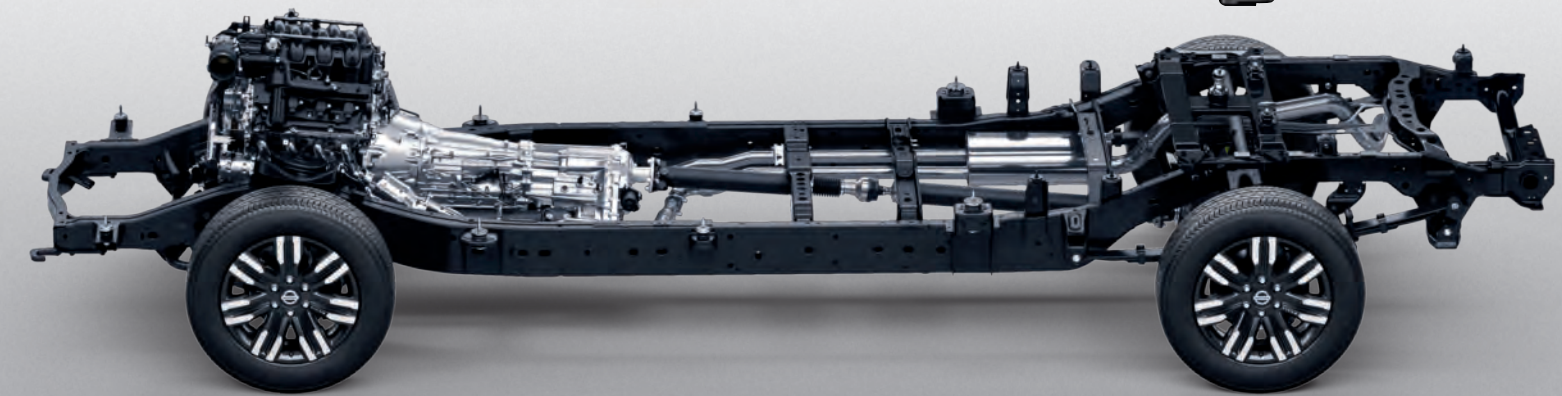



CHOOSE YOUR COLOR

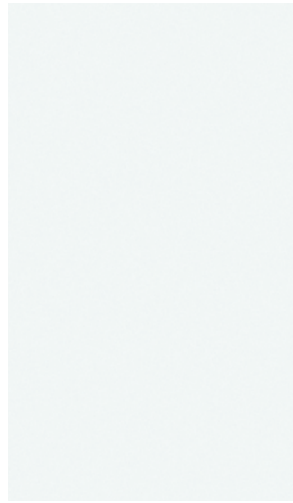

Glacier White

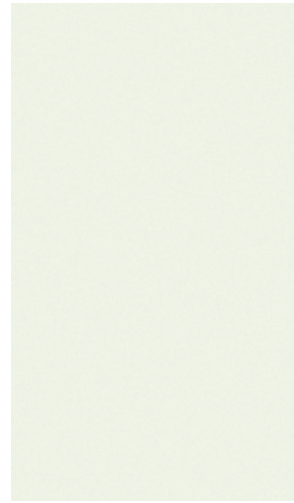

Pearl White TriCoat<sup>35</sup>



Gun Metallic



Baja Storm Pearl<sup>35</sup>

	S	SV	PRO-4X <sup>®</sup>	PR
Charcoal Cloth	■	■	■	
Beige Cloth		■		
Charcoal Leather <sup>37</sup>			C	
Premium Brown Leather <sup>37</sup>				■ <sup>36</sup>

	S	SV	PRO-4X <sup>®</sup>	PR
Charcoal Cloth				
Beige Cloth				
Charcoal Leather <sup>37</sup>				
Premium Brown Leather <sup>37</sup>				■ <sup>36</sup>

	S	SV	PRO-4X <sup>®</sup>	PR
Charcoal Cloth	■	■	■	
Beige Cloth		■		
Charcoal Leather <sup>37</sup>			C	
Premium Brown Leather <sup>37</sup>				■ <sup>36</sup>

	S	SV	PRO-4X <sup>®</sup>	PR
Charcoal Cloth			■	
Beige Cloth				
Charcoal Leather <sup>37</sup>			C	
Premium Brown Leather <sup>37</sup>				■ <sup>36</sup>

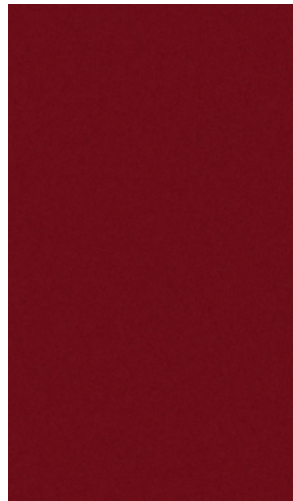

Cardinal Red TriCoat<sup>35</sup>



Red Alert

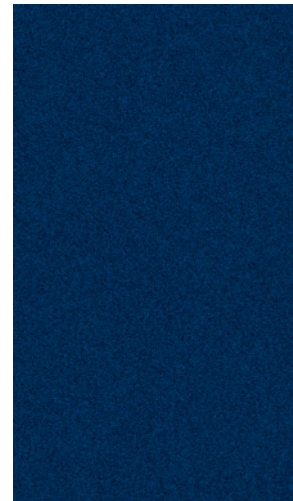

Deep Blue Pearl



Super Black

	S	SV	PRO-4X <sup>®</sup>	PR
Charcoal Cloth				
Beige Cloth				
Charcoal Leather <sup>37</sup>				
Premium Brown Leather <sup>37</sup>				■ <sup>36</sup>

	S	SV	PRO-4X <sup>®</sup>	PR
Charcoal Cloth	■	■	■	
Beige Cloth		■		
Charcoal Leather <sup>37</sup>			C	
Premium Brown Leather <sup>37</sup>				■ <sup>36</sup>

	S	SV	PRO-4X <sup>®</sup>	PR
Charcoal Cloth	■	■	■	
Beige Cloth		■		
Charcoal Leather <sup>37</sup>			C	
Premium Brown Leather <sup>37</sup>				■ <sup>36</sup>

	S	SV	PRO-4X <sup>®</sup>	PR
Charcoal Cloth	■	■	■	
Beige Cloth		■		
Charcoal Leather <sup>37</sup>			C	
Premium Brown Leather <sup>37</sup>				■ <sup>36</sup>

■ Standard  
C Part of PRO-4X Convenience Package

Nissan has taken care to ensure that the color swatches presented here are the closest possible representations of actual vehicle colors. Swatches may vary slightly due to the printing process and whether viewed in daylight, fluorescent or incandescent light. Please see the actual colors at your local Nissan dealer.

CHOOSE YOUR INTERIOR



Nissan TITAN<sup>®</sup> Crew Cab Platinum Reserve shown in Premium Brown Leather.<sup>37</sup>



Charcoal Cloth S|SV

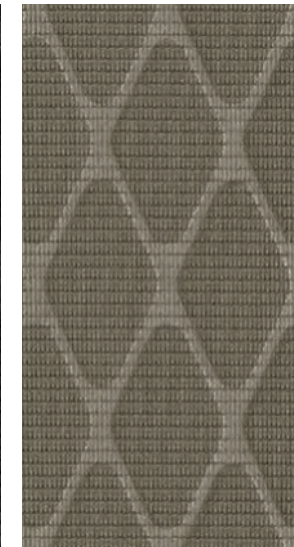

Beige Cloth SV



Charcoal Cloth PRO-4X<sup>®</sup>



Charcoal Leather<sup>37</sup> PRO-4X<sup>®</sup>

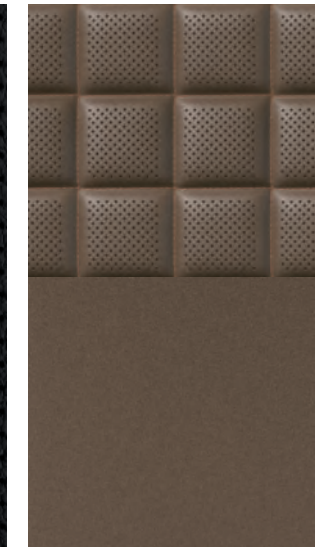

Premium Brown Leather<sup>37</sup> Platinum Reserve



## CHOOSE YOUR TRIM LEVEL

**S**

5.6-liter 32-valve V8 engine, 9-speed automatic transmission, 6.5-ft truck bed, 13" front and rear vented disc brakes, Intelligent Forward Collision Warning,<sup>38</sup> Automatic Emergency Braking with Pedestrian Detection,<sup>11</sup> Lane Departure Warning,<sup>15</sup> Blind Spot Warning,<sup>14</sup> Rear Cross Traffic Alert,<sup>13</sup> RearView Monitor,<sup>39</sup> Rear Sonar System,<sup>40</sup> Rear Automatic Braking,<sup>12</sup> High Beam Assist, Intelligent Driver Alertness,<sup>41</sup> Hill start assist, Vehicle Dynamic Control (VDC)<sup>42</sup> with Traction Control System (TCS), Trailer Sway Control,<sup>25</sup> 18" Silver-metallic styled steel wheels, P265/70R18 all-season tires, Black bumpers, Overhead LED cargo bed lights, Remote keyless entry with push button ignition, Rear Door Alert System,<sup>43</sup> Easy Clean<sup>®</sup> vinyl flooring, 40/20/40-split bench front seat with flip-down center seat, 60/40-split bench rear seat with center flip-down armrest, Stain-resistant cloth seat trim, Column shifter with manual shift mode, 7" Advanced Drive-Assist Display,<sup>28</sup> NissanConnect<sup>®</sup> 8" color touch-screen display,<sup>28</sup> Apple CarPlay<sup>®</sup> integration,<sup>18</sup> Android Auto<sup>™</sup> compatibility,<sup>18</sup> Voice Recognition,<sup>22</sup> Hands-free Text Messaging Assistant,<sup>21</sup> Bluetooth<sup>®</sup> Hands-free Phone System,<sup>18</sup> SiriusXM Radio,<sup>18</sup> Streaming Audio via Bluetooth,<sup>918</sup> AM/FM audio system, One USB-A and one USB-C port,<sup>16</sup> Illuminated steering wheel-mounted audio controls, Six speakers



**King Cab<sup>®</sup> Adds:** Wide-opening rear doors, Front overhead storage console<sup>26</sup>

**Crew Cab Adds:** 5.5-ft truck bed, power rear side windows, two additional cup holders

**XD S Adds:** Switch-operated 2-speed transfer case, 14" front and rear vented disc brakes, 17" Styled steel wheels, LT245/75R17 all-season tires, Factory-applied spray-on bedliner, Trailer Sway Control,<sup>25</sup> Class IV tow hitch receiver with 4-pin/7-pin wiring harness,<sup>25</sup> Front overhead storage console<sup>26</sup>

**S UTILITY PACKAGE:** Standard on King Cab

**SV** INCLUDES S EQUIPMENT PLUS:

Intelligent Cruise Control,<sup>20</sup> 18" Dark-painted machine-finished aluminum-alloy wheels (TITAN only), Oil pan, fuel tank and transmission skid plates (4x4 only), Removable front aero spoiler (TITAN only), Front tow hooks (4x4 only), Prewiring for off-road lighting, LED taillights, Body-color front and rear bumpers, Power heated black outside mirrors, Carpeted flooring

**XD SV Adds:** Trailer brake controller,<sup>25</sup> Trailer light check,<sup>25</sup> Power heated manually extendable tow mirrors with turn signal indicators and convex spotter mirror, Side mirrors with puddle lights

**SV CONVENIENCE PACKAGE:** Standard on King Cab



**PRO-4X<sup>®</sup>** INCLUDES SV EQUIPMENT PLUS:

2-speed transfer case (4WD), Electronic locking rear differential, Bilstein<sup>®</sup> off-road performance shocks, Traffic Sign Recognition,<sup>44</sup> Hill descent control, 18" Dark-finished aluminum-alloy wheels with all-terrain tires, Transfer case skid plates, Lava Red front tow hooks, LED headlights with LED signature Daytime Running Lights, LED fog lights, LED taillights with integrated LED signature, Charcoal-painted rear bumper and black overfenders, Factory-applied spray-on bedliner, Class IV tow hitch receiver with 4-pin/7-pin wiring harness,<sup>25</sup> Dual Zone Automatic Temperature Control, Rear air conditioning vents, Nissan Intelligent Key<sup>®</sup> with Push Button Ignition, Rain-sensing wipers, Auto-dimming rearview mirror, HomeLink<sup>®</sup> Universal Transceiver, Center console with 120-volt and 12-volt outlets and smartphone holder,<sup>27</sup> Interior mood lighting, Front overhead storage console,<sup>26</sup> Lockable rear-seat cargo organizer,<sup>26</sup> Front captain's chairs with 8-way power adjustable driver's seat and power lumbar, PRO-4X cloth embroidered seats with contrast stitching, Leather-wrapped steering wheel, Carpeted floor mats with PRO-4X logo, NissanConnect<sup>®</sup> 9" color touch-screen display,<sup>28</sup> Nissan Door to Door Navigation with Premium Traffic,<sup>22</sup> NissanConnect<sup>®</sup> Services powered by SiriusXM,<sup>18</sup> NissanConnect<sup>®</sup> with Wi-Fi Hotspot,<sup>18</sup> Two rear illuminated USB-A ports<sup>16</sup>

**XD PRO-4X Adds:** Front and Rear Sonar System,<sup>40</sup> Power sliding back window with defroster, Utili-track<sup>®</sup> Channel System with four tie-down cleats,<sup>26</sup> Bed-mounted 120-volt AC power outlet,<sup>27</sup> LED under-rail bed and tailgate area lighting, Electronic tailgate lock, Rear bumper step assist, Fender<sup>®</sup> premium audio system with 12 speakers



**PLATINUM RESERVE** INCLUDES SV EQUIPMENT PLUS:

Intelligent Around View<sup>®</sup> Monitor,<sup>23</sup> Front and Rear Sonar System,<sup>40</sup> Traffic Sign Recognition,<sup>44</sup> Trailer brake controller,<sup>25</sup> Trailer light check,<sup>25</sup> 20" Two-tone painted aluminum-alloy wheels (TITAN only), Front tow hooks, LED headlights with LED signature Daytime Running Lights, LED taillights with integrated LED signature, LED fog lights, Two-tone exterior paint, Brushed satin-finished grille and tailgate finisher, Power-folding and auto-dimming driver's outside mirror, Outside mirrors with reverse tilt-down feature, Chrome mirror caps, Power sliding back window with defroster, Running Boards with Chrome Accents, Utili-track<sup>®</sup> Channel System with four tie-down cleats,<sup>26</sup> Factory-applied spray-on bedliner, Bed-mounted 120-volt AC power outlet,<sup>27</sup> LED under-rail bed and tailgate area illumination, Class IV tow hitch receiver with 4-pin/7-pin wiring harness,<sup>25</sup> Dual Zone Automatic Temperature Control, Rear air conditioning vents, Nissan Intelligent Key with Push Button Ignition, Remote Engine Start System<sup>45</sup> with Intelligent Climate Control, Power tilt and telescoping steering column, Auto-dimming rearview mirror, HomeLink<sup>®</sup> Universal Transceiver, Center console with 120-volt and 12-volt outlets and smartphone holder,<sup>27</sup> Interior mood lighting, Front overhead storage console,<sup>26</sup> Lockable rear-seat cargo organizer,<sup>26</sup> Front captain's chairs with 8-way power adjustable driver's seat and power lumbar, 4-way power adjustable passenger seat, Climate-controlled front seats (heated and cooled), Heated outboard rear seats, Memory system – driver's seat, steering wheel, and outside mirrors, Premium leather-appointed seats with Platinum Reserve logo, Heated leather-wrapped steering wheel, Metallic kick plate finisher with Platinum Reserve logo, NissanConnect<sup>®</sup> 9" color touch-screen display,<sup>28</sup> Nissan Door to Door Navigation with Premium Traffic,<sup>22</sup> NissanConnect<sup>®</sup> with Wi-Fi Hotspot,<sup>18</sup> Fender<sup>®</sup> premium audio system with 12 speakers, Two rear illuminated USB-A ports<sup>16</sup>

**XD Platinum Reserve Adds:** 20" Dark-painted machine-finished aluminum-alloy wheels, Removable front aero spoiler, Integrated Gooseneck Hitch with 7-pin in-bed wiring harness<sup>8</sup>





CHOOSE YOUR PACKAGE



**S UTILITY PKG.** | TITAN® CC

Front overhead storage console,<sup>26</sup> Factory-applied spray-on bedliner, Class IV tow hitch receiver with 4-pin/7-pin wiring harness<sup>25</sup>

**TITAN KC:** Standard



**SV TOW PKG.** | TITAN KC / TITAN CC

Class IV tow hitch receiver with 4-pin/7-pin wiring harness,<sup>25</sup> Power heated manually extendable tow mirrors with integrated turn signal indicators and puddle lights, Trailer brake controller,<sup>25</sup> Trailer light check,<sup>25</sup> Front tow hooks



**SV CHROME PKG.** | TITAN CC

Chrome front grille (inner and outer), 20" Chrome-clad aluminum-alloy wheels, Chrome exhaust finisher, Chrome exterior door handles, Metallic kick plates



**PRO-4X® UTILITY PKG.** | TITAN

Utili-track® Channel System with four tie-down cleats,<sup>26</sup> LED under-rail bed and tailgate area lighting, Bed-mounted 120-volt AC power outlet,<sup>27</sup> Electronic tailgate lock, Front and Rear Sonar System,<sup>40</sup> Fender® premium audio system with 12 speakers, Power sliding back window with defroster, Trailer brake controller,<sup>25</sup> Trailer light check,<sup>25</sup> Proximity Activation (LED signature headlights, cargo lights, LED bed-mounted lights), Rear bumper step assist

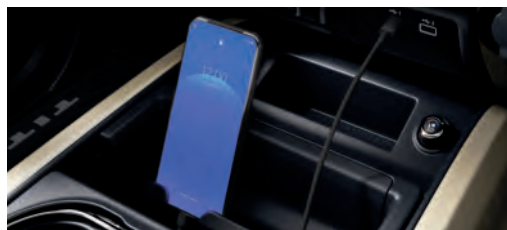

**SV CONVENIENCE PKG.** | TITAN CC / TITAN XD

20" Silver-painted aluminum-alloy wheels (TITAN XD only), Front and Rear Sonar System,<sup>40</sup> Integrated Gooseneck Hitch with 7-pin in-bed wiring harness (TITAN XD only),<sup>8</sup> Dual Zone Automatic Temperature Control, Rear air conditioning vents, Nissan Intelligent Key® with Push Button Ignition, Auto-dimming rearview mirror, Front captain's chairs with 8-way power adjustable driver's seat and power lumbar, Center console with 120-volt and 12-volt outlets and smartphone holder,<sup>27</sup> Two rear illuminated USB-A ports,<sup>16</sup> Heated front seats, Remote Engine Start System<sup>45</sup> with Intelligent Climate Control, Leather-wrapped steering wheel, Sun visors with illuminated vanity mirrors and extension, Front overhead storage console,<sup>26</sup> Interior mood lighting, NissanConnect® 9" color touch-screen display,<sup>28</sup> Nissan Door to Door Navigation with Premium Traffic,<sup>22</sup> SiriusXM Traffic and Travel Link,<sup>18</sup> NissanConnect® Services powered by SiriusXM,<sup>18</sup> NissanConnect® with Wi-Fi Hotspot,<sup>18</sup> Power sliding back window with defroster, Traffic Sign Recognition<sup>44</sup>

**TITAN KC:** Standard



**PRO-4X MOONROOF PKG.** | TITAN / TITAN XD  
**PRO-4X PREMIUM PKG.** | TITAN XD

Climate-controlled front seats (heated and cooled), Dual Panel Panoramic Moonroof

**XD Adds:** Intelligent Around View® Monitor,<sup>23</sup> TITAN Boxes<sup>26</sup>



**PRO-4X® CONVENIENCE PKG.** | TITAN / TITAN XD

Power heated black side mirrors with turn signal indicators and puddle lights, Power-folding driver's outside mirrors with reverse tilt-down feature (TITAN only), Integrated Gooseneck Hitch with 7-pin in-bed wiring harness (TITAN XD only),<sup>8</sup> Remote Engine Start System<sup>45</sup> with Intelligent Climate Control, PRO-4X leather-appointed seats with contrast stitching, 4-way power adjustable passenger's seat, Heated front seats, Heated outboard rear seats, Power tilt and telescoping steering column, Heated steering wheel, Memory System – driver's seat, steering wheel, and auto-dimming outside mirrors, Intelligent Around View® Monitor (TITAN only)<sup>23</sup>



**SV UTILITY PKG.** | TITAN KC / TITAN CC / TITAN XD

Intelligent Auto Headlights, Utili-track® Channel System with four tie-down cleats,<sup>26</sup> Factory-applied spray-on bedliner, LED under-rail bed and tailgate area lighting, Bed-mounted 120-volt AC power outlet,<sup>27</sup> Electronic tailgate lock, Rear bumper step assist, Lockable rear-seat cargo organizer,<sup>26</sup> HomeLink® Universal Transceiver, Rain-sensing wipers



**S/SV HEAVY DUTY GAWR PKG.** | TITAN XD

High-capacity front springs



**PLAT. RES. UTILITY PKG.** | TITAN / TITAN XD

TITAN Boxes,<sup>26</sup> Electronic tailgate lock, Rear bumper step assist



**PLAT. RES. MOONROOF PKG.** | TITAN / TITAN XD

Dual Panel Panoramic Moonroof



**PLAT. RES. MONOTONE PAINT PKG.** | TITAN / TITAN XD

Body-color front and rear bumpers, Wheel arch moldings, Rocker panels



## CHOOSE YOUR ACCESSORIES

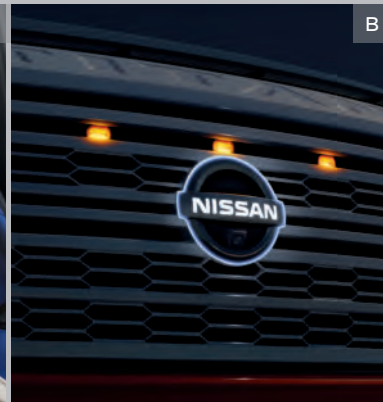

### A. Water-Resistant Seat Covers

Protect your TITAN's plush factory seats, and then go enjoy your day in the dirt.

### B. Illuminated Grille Emblem and Marker Lights (Sold separately. Fender marker lights not shown.)

Add flair and style to your grille and front fenders.

### C. TITAN Logo Approach Light

Projects a glowing TITAN logo onto the ground.

### D. TITAN Illuminated Kick Plates

Premium as soon as you open the door.

### E. Running Boards with Chrome Accents

Step up with more style and more body protection.

### F. Sliding Bed Extender<sup>26</sup>

Extend the possibilities.

### G. TITAN Boxes<sup>26</sup>

Store and protect your gear. Boxes are lockable and removable.

### H. Impact Sensor

Sounds an alert if there's a small impact or if a break-in or wheel theft is attempted.

### Additional Accessories:

- Remote Engine Start System<sup>45</sup>
- Skid Plate
- Sliding Bed Divider
- Fixed Bed Extender
- Aluminum-insert Door Sill Plates
- Door Scuff Protector
- Stainless Steel Exhaust Finisher
- Gooseneck Hitch Ball and Anchor Kit<sup>8, 17, 25</sup>
- 5th Wheel Adapter<sup>25</sup>
- Affiliated Yakima® FullTilt 4<sup>47</sup>
- And More

For more information and to shop online for TITAN® Genuine Nissan Accessories, go to [bit.ly/22TitanXD-Accys](https://bit.ly/22TitanXD-Accys)

To see Genuine Nissan Accessories in action, go to [bit.ly/22TitanXD-Video](https://bit.ly/22TitanXD-Video)

## NISSAN TITAN® ACCESSORIES

### Turn brand-new into all you

Every Genuine Nissan Accessory is custom-fit, custom-designed and durability-tested. Each one is backed by Nissan's 5-year/100,000-mile (whichever occurs first) limited warranty (if installed by dealer at the time of purchase), and can be financed when installed by dealer at time of purchase.<sup>46</sup> Affiliated Yakima® accessories are not warranted by Nissan. Refer to product manufacturer for warranty details. Nissan Limited Warranty does not cover damages or failures to the vehicle caused by improper installation or alterations of any Nissan approved accessory or component. Contact your dealer/retailer for details.



Nissan TITAN® Crew Cab SV 4x4 with Convenience Package shown in Gun Metallic with 20" Black Aluminum-alloy Wheels, Splash Guards, Tow Hooks (Standard on 4x4), Hood Wind Deflector, Side-Window Deflectors, Tow Mirrors, Sport Bar, NISMO® LED Off-road Lights,<sup>47</sup> Loop Step Rails, and Rear Bumper Step Assist.



## CHOOSE YOUR ACCESSORIES



A

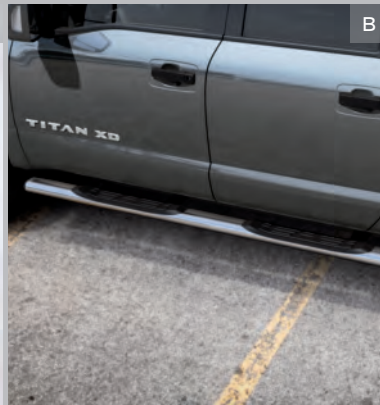

B



C



D



E



F



G



H

Along with the other hard-working accessories listed below, you'll find a full line of accessories designed specifically to work with the unique system of channels and cleats in TITAN's incredibly versatile Utili-track® system.<sup>26</sup>

**A. Virtual Key<sup>48</sup>**  
The future of locking doors and starting your vehicle is here.

**B. Chrome Step Rails**  
Get a leg up in style.

**C. Lockable Rear-seat Cargo Organizer with Fold-out Flat Floor<sup>26</sup>**  
Under-seat storage that's out of sight.

**D. Tailgate Audio by KICKER®**  
Feel the beat whether you're working or playing.

**E. Bed Tent<sup>26</sup>**  
It's your TITAN! It's your campsite! It's both!

**F. 4" Drop Hitch Ball Mount, Class III<sup>25</sup>**  
If you're getting hitched, do it right.

**G. PRO-4X® Mud Flaps**  
Deflect mud from your TITAN like a pro.

**H. All-Season Floor Mats - High Wall Liners**  
Don't let the muck mess up your truck.

For more information and to shop online for TITAN® Genuine Nissan Accessories, go to [bit.ly/22TitanXD-Accys](https://bit.ly/22TitanXD-Accys)

To see Genuine Nissan Accessories in action, go to [bit.ly/22TitanXD-Video](https://bit.ly/22TitanXD-Video)



**Nissan TITAN XD® Crew Cab SV 4x4** with Convenience and Utility Packages shown in Gun Metallic with 20" Black Aluminum-alloy Wheels, Tow Mirrors (Standard on SV), TITAN Boxes,<sup>26</sup> TITAN Mud Flaps, Rugged Step Boards, Tailgate Gap Cover, Tie-down Cleats (Standard on SV with Utility Package),<sup>26</sup> Bed Assist Grip, and Rear Bumper Step Assist (Standard on SV with Utility Package).



# SPECIFICATIONS

	TITAN®						TITAN XD®			
	King Cab®		Crew Cab				Crew Cab			
	S	SV	S	SV	PRO-4X®	Platinum Reserve	S	SV	PRO-4X®	Platinum Reserve
<b>Engine</b>										
5.6-liter Direct Injection Gasoline (DIG) DOHC 32-valve V8 engine Horsepower – 400 hp @ 5,800 rpm <sup>3</sup> Torque – 413 lb-ft @ 4,000 rpm <sup>3</sup>	■	■	■	■	■	■	■	■	■	■
<b>Drivetrain</b>										
9-speed automatic transmission	■	■	■	■	■	■	■	■	■	■
Switch-operated 2-speed transfer case 4WD	□	□	□	□	■	□	■	■	■	■
Electronic locking rear differential					■				■	
<b>Brakes</b>										
13.78" x 1.2" front vented disc and 13.58" x 0.8" rear vented disc brakes	■	■	■	■	■	■				
14.17" x 1.5" front vented disc and 14.37" x 1.2" rear vented disc brakes							■	■	■	■
4-wheel Anti-lock Braking System (ABS)	■	■	■	■	■	■	■	■	■	■
Electronic Brake force Distribution (EBD) and Brake Assist <sup>49</sup>	■	■	■	■	■	■	■	■	■	■
<b>Suspension/Chassis Bracing/Steering</b>										
Independent double-wishbone front suspension with stabilizer bar	■	■	■	■	■	■	■	■	■	■
Multi-leaf rear suspension with solid axle and stabilizer bar	■	■	■	■	■	■	■	■	■	■
Bilstein® off-road performance shocks					■					
High-capacity front springs							HD	HD		
<b>Driver Assistance Technologies</b>										
Intelligent Cruise Control <sup>20</sup>		■	■	■	■	■		■	■	■
Intelligent Forward Collision Warning <sup>38</sup>	■	■	■	■	■	■	■	■	■	■
Automatic Emergency Braking with Pedestrian Detection <sup>11</sup>	■	■	■	■	■	■	■	■	■	■
Lane Departure Warning <sup>15</sup>	■	■	■	■	■	■	■	■	■	■
Blind Spot Warning <sup>14</sup>	■	■	■	■	■	■	■	■	■	■
Rear Cross Traffic Alert <sup>13</sup>	■	■	■	■	■	■	■	■	■	■
RearView Monitor <sup>39</sup>	■	■	■	■	■	■	■	■	■	■
Intelligent Around View® Monitor <sup>23</sup>					C2	■			P	■
Rear Sonar System <sup>40</sup>	■		■	■	■	■	■	■	P	■
Front and Rear Sonar System <sup>40</sup>		■		C1	U3	■		C1	■	■
Rear Automatic Braking <sup>12</sup>	■	■	■	■	■	■	■	■	■	■
High Beam Assist	■	■	■	■	■	■	■	■	■	■
Intelligent Driver Alertness <sup>41</sup>	■	■	■	■	■	■	■	■	■	■
Traffic Sign Recognition <sup>44</sup>	■	■		C1	■	■	■	C1	■	■
Hill start assist	■	■	■	■	■	■	■	■	■	■
Hill descent control						■				■
Vehicle Dynamic Control (VDC) <sup>42</sup> with Traction Control System (TCS)	■	■	■	■	■	■	■	■	■	■
Active Brake Limited Slip (ABLS)	■	■	■	■	■	■	■	■	■	■
Trailer Sway Control <sup>25</sup>	■	■	■	■	■	■	■	■	■	■
Trailer brake controller <sup>25</sup>		T1		T1	U3	■		■	■	■
Trailer light check <sup>25</sup>		T1		T1	U3	■		■	■	■
<b>Wheels/Tires</b>										
17" styled steel wheels							■	■		
18" Silver-metallic styled steel wheels	■									
18" Dark-painted machine-finished aluminum-alloy wheels				■						
18" Dark-finished aluminum-alloy wheels					■				■	

TITAN Packages			
■ Standard	T1 Part of SV Towing Package	C2 Part of PRO-4X Convenience Package	M2 Part of Platinum Reserve Moonroof Package
□ Optional	U2 Part of SV Utility Package	M1 Part of PRO-4X Moonroof Package	MP Part of Platinum Reserve Monotone Paint Package
U1 Part of S Utility Package	CH Part of SV Chrome Package	U4 Part of Platinum Reserve Utility Package	
C1 Part of SV Convenience Package	U3 Part of PRO-4X Utility Package		

TITAN XD Packages			
■ Standard	C1 Part of SV Convenience Package	C2 Part of PRO-4X Convenience Package	M2 Part of Platinum Reserve Moonroof Package
HD Part of Heavy Duty GAWR Package (S, SV)	U2 Part of SV Utility Package	P Part of PRO-4X Premium Package	MP Part of Platinum Reserve Monotone Paint Package

	TITAN®						TITAN XD®			
	King Cab®		Crew Cab				Crew Cab			
	S	SV	S	SV	PRO-4X®	Platinum Reserve	S	SV	PRO-4X®	Platinum Reserve
<b>Wheels/Tires (continued)</b>										
20" Chrome-clad aluminum-alloy wheels				CH						
20" Silver-painted aluminum-alloy wheels										
20" Two-tone painted aluminum-alloy wheels										■
20" Dark-painted machine-finished aluminum-alloy wheels										■
LT245/75R17 all-season tires										
P265/70R18 all-season tires	■	■	■	■						
LT275/65R18 all-terrain tires										
P275/70R18 all-terrain tires					■					
LT265/60R20 all-season tires									CH	■
P275/60R20 all-season tires										■

Exterior Features										
Removable front aero spoiler		■		■		■				■
Lower radiator skid plate	■	■	■	■	■	■	■	■	■	■
Oil pan, fuel tank, and transmission skid plates (4x4 models)		■		■	■	■				■
Transfer case skid plate						■				■
Front tow hooks (4x2 models)		T1		T1		■				■
Front tow hooks (4x4 models)		■		■	■	■				■
Intelligent Auto Headlights		U2		U2	■	■				■
LED signature headlights, LED Daytime Running Lights, and LED fog lights						■				■
Pre-wiring for off-road lighting		■		■	■	■				■
LED taillights		■		■		■				■
LED taillights with integrated signature						■				■
Black bumpers	■		■				■			■
Body-color front bumper		■		■	■	MP				MP
Body-color rear bumper		■		■	■	MP				MP
Charcoal-painted rear bumper and black overfenders					■					■
Gun Metallic-painted overfenders and rocker panels						■				■
Body-color overfenders and rocker panels						MP				MP
Chrome-finished grille (inner and outer)				CH						
Brushed satin-finished grille (inner and outer) and tailgate finisher						■				■
Power heated black outside mirrors					■					■
Side mirrors with convex spotter mirror						■				■
Power heated manually extendable tow mirrors with turn signal indicators and puddle lights		T1		T1		■				■
Outside mirrors with reverse tilt-down feature					C2	■				■
Power-folding driver's outside mirrors						■				■
Auto-dimming driver's-side outside mirrors					C2	■				■
Dual Panel Panoramic Moonroof					M1	M2				■
Power sliding back window with defroster		■		C1	U3	■				■
Running boards with chrome accents						■				■
Utili-track® Channel System with 4 tie-down cleats <sup>26</sup>		U2		U2	U3	■				■
Factory-applied spray-on bedliner	■	U2	U1	U2	■	■	■	U2	■	■
TITAN Boxes <sup>26</sup>						U4				■
Bed-mounted 120-volt AC power outlet <sup>27</sup>		U2		U2	U3	■		U2	■	■
Overhead LED cargo bed lights	■	■	■	■	■	■	■	■	■	■
LED under-rail bed and tailgate area lighting		U2		U2	U3	■		U2	■	■
Rear bumper step assist		U2		U2	U3	U4		U2	■	U4
Class IV tow hitch receiver with 4-pin/7-pin wiring harness <sup>27</sup>	■	T1	U1	T1	■	■	■	■	■	■
Integrated gooseneck hitch <sup>8</sup>										
Chrome exhaust finisher				CH		■				■

Comfort/Convenience										
Dual Zone Automatic Temperature Control		■		C1	■	■				■
Rear air conditioning vents (Crew Cab only)		■		C1	■	■				■
Remote keyless entry with Push Button Ignition	■			■			■	■		■



	TITAN®					
	King Cab®	Crew Cab				
	S	SV	S	SV	PRO-4X®	Platinum Reserve
<b>Comfort/Convenience (continued)</b>						
Nissan Intelligent Key® with Push Button Ignition		■		C1	■	■
Remote Engine Start System <sup>45</sup> with Intelligent Climate Control		■		C1	C2	■
Proximity Activation (LED signature headlights, cargo lights, LED bed-mounted lights)					U3	■
Rear Door Alert <sup>43</sup>	■		■			■
Rain-sensing wipers						■
Auto-dimming rearview mirror		■		C1	■	■
HomeLink® Universal Transceiver		■		U2	■	■
Center console with 120-volt AC and 12-volt DC power outlets and two illuminated USB ports <sup>16, 27</sup>		■		C1	■	■
Center console smartphone holder		■		C1	■	■
Front overhead storage console <sup>26</sup>	■	■	U1	C1	■	■
Lockable rear-seat cargo organizer <sup>26</sup>		■	U2	■	■	■

<b>Seating/Appointments</b>						
40/20/40-split bench front seat with flip-down center seat with armrest	■		■	■		
Front captain's chairs with center console		■		C1	■	■
8-way power adjustable driver's seat and power lumbar support		■		C1	■	■
4-way power adjustable passenger's seat					C2	■
Heated front seats		■		C1	C2	
Climate-controlled front seats (heated and cooled)					M1	■
60/40-split fold-up rear bench seat	■	■	■	■	■	■
Heated outboard rear seats					C2	■
Memory System – driver's seat and steering wheel					C2	
Memory System – driver's seat, steering wheel, and outside mirrors						■
Stain-resistant cloth seat trim	■	■	■	■		
PRO-4X cloth embroidered seats with contrast stitching					■	
PRO-4X Leather-appointed embroidered seats with contrast stitching					C2	
Premium leather-appointed seats with Platinum Reserve logo						■
Leather-wrapped steering wheel		■		C1	■	■
Heated leather-wrapped steering wheel					C2	■
Column shifter with manual shift mode	■	■	■	■	■	■
Metallic kick plates with Platinum Reserve logo						■

<b>Infotainment</b>						
7" Advanced Drive-Assist Display <sup>28</sup>	■	■	■	■	■	■
NissanConnect® 8" color touch-screen display <sup>28</sup>	■					
NissanConnect® 9" color touch-screen display <sup>28</sup>		■		C1	■	■
Nissan Door to Door Navigation with Premium Traffic <sup>22</sup>		■		C1	■	■
Apple CarPlay® integration <sup>18</sup>	■	■	■	■	■	■
Android Auto™ compatibility <sup>18</sup>	■	■	■	■	■	■
NissanConnect® Services powered by SiriusXM with trial access to 5-year Select, 5-year Plus and 6-month Premium packages <sup>18</sup>		■		C1	■	■
NissanConnect® with Wi-Fi Hotspot <sup>18</sup>	■	■	■	■	■	■
Voice Recognition <sup>22</sup>	■	■	■	■	■	■
Bluetooth® Hands-free Phone System <sup>18</sup> and Hands-free Text Messaging Assistant <sup>21</sup>	■	■	■	■	■	■
Fender® premium audio system with twelve speakers, including center speaker and subwoofer					U3	■
SiriusXM Radio with 3-month subscription included <sup>18</sup>	■	■	■	■	■	■
Streaming Audio via Bluetooth® <sup>18</sup>	■	■	■	■	■	■

<b>Safety/Security</b>						
Nissan Air Bag System with dual-stage driver and dual-stage front-passenger supplemental air bags with seat-belt classification sensors <sup>50</sup>	■	■	■	■	■	■
Driver and front-passenger seat-mounted side-impact supplemental air bags <sup>50</sup>	■	■	■	■	■	■
Driver and front-passenger supplemental knee air bag <sup>50</sup>	■	■	■	■	■	■
Roof-mounted curtain supplemental air bags for side-impact and rollover head protection for front and rear outboard occupants with rollover sensor <sup>50</sup>	■	■	■	■	■	■
Tire Pressure Monitoring System (TPMS) with Easy-Fill Tire Alert <sup>29, 51</sup>	■	■	■	■	■	■
Nissan Vehicle Immobilizer System and Vehicle Security System	■	■	■	■	■	■

TITAN XD®			
Crew Cab			
S	SV	PRO-4X®	Platinum Reserve
	C1	■	■
	C1	C2	■
		■	■
■	■	■	■
	U2	■	■
	C1	■	■
	U2	■	■
	C1	■	■
	C1	■	■
■	C1	■	■
	U2	■	■

■	■		
	C1	■	■
	C1	■	■
		C2	■
	C1	C2	
		P	■
■	■	■	■
		C2	■
■	■	■	■
		C2	■
■	■	■	■
		C2	■
■	■	■	■

■	■	■	■
■			
	C1	■	■
	C1	■	■
■	■	■	■
■	■	■	■
■	■	■	■
■	■	■	■

■	■	■	■
■	■	■	■
■	■	■	■

## DIMENSIONS/CAPACITIES/MPG

Exterior Dimensions – Inches			
	TITAN King Cab	TITAN Crew Cab	TITAN XD Crew Cab
Wheelbase	139.8	139.8	151.6
Overall length:			
S, SV	228.2	228.2	243.4
PRO-4X, Platinum Reserve	—	229.5	244.4
Overall width:			
S, SV	79.5	79.5	79.5
PRO-4X, Platinum Reserve	—	80.7	80.7
Overall height:			
4x2: S, SV	75.1	75.4	—
4x2: Platinum Reserve	—	75.6	—
4x4: S, SV	75.7	76.0	78.0
4x4: PRO-4X	—	77.2	78.4
4x4: Platinum Reserve	—	77.2	78.9
Bed length	78.7	67.0	78.7
Bed width (between wheel wells)	63.8 (50.0)	63.8 (50.0)	63.8 (50.0)
Bed depth	20.8	20.8	20.8
<b>Interior</b>			
Head room with moonroof: front/rear	—	38.7/37.6	38.7/37.6
Head room without moonroof: front/rear	40.9/38.7	41.0/40.4	41.0/40.4
Leg room: front/rear	41.8/24.8	41.8/38.5	41.8/38.5
Hip room: front/rear	60.8/59.4	60.8/60.3	60.8/60.3
Shoulder room: front/rear	63.3/64.6	63.3/63.6	63.3/63.6

TITAN Payload and Towing – Lbs.			
Maximum payload (4x2) <sup>52</sup>	1,620	1,600	—
Maximum payload (4x4) <sup>52</sup>	1,710	1,650	2,430
Maximum towing (4x2) <sup>25</sup>	9,320	9,310	—
Maximum towing (4x4) <sup>25</sup>	9,200	9,160	10,920
Maximum towing gooseneck (4x4) <sup>25</sup>	—	—	11,060

2022 TITAN EPA Fuel Economy Estimates <sup>53</sup>			
<b>City/Highway/Combined MPG</b>			
4x2: S, SV	16/21/18	16/21/18	—
4x4: S, SV	15/21/18	15/21/18	—
4x4: PRO-4X	—	15/20/17	—
4x2: Platinum Reserve	—	16/21/18	—
4x4: Platinum Reserve	—	15/21/18	—

## NISSAN ROADSIDE ASSISTANCE

Your peace of mind is on us. For five years or 100,000 miles, whichever comes first, your new Nissan is covered for the following:<sup>54</sup>

- Flat-tire changes
- Trip Interruption benefits
- Jump starts
- Vehicle lockouts
- Emergency fuel delivery

Follow Nissan on:



visit [NissanUSA.com/titan](https://www.nissanusa.com/titan)

PRINTED IN POLAND

<sup>1</sup>Claim based on years/mileage (whichever occurs first) covered under the New Vehicle Limited Warranty basic coverage. *Ward's* in-market Large Pickup Segmentation and Small Pickup Segmentation (excluding EVs) v. 2022 TITAN. Nissan's New Vehicle Limited Warranty basic coverage excludes tires, corrosion coverage and federal and California emission performance and defect coverage. Other terms and conditions also apply. See dealer for complete warranty details. Warranty claim is current at time of publication. <sup>2</sup>*Ward's* Segmentation (excluding EVs). 2022 TITAN vs. latest in-market Large Pickup Segment competitors. Horsepower figures based on Premium Fuel Only. Base models compared. Based on manufacturer websites. <sup>3</sup>Horsepower and torque figure based on premium fuel only. <sup>4</sup>*Ward's* Segmentation (excluding EVs). 2022 TITAN vs. latest in-market Large Pickup Segment competitors. *Safety* technology refers to advanced vehicle features including driver assistance systems and features. See Owner's Manual for safety information. Base models compared. Based on manufacturer websites. <sup>5</sup>*Ward's* Segmentation (excluding EVs). 2022 TITAN vs. latest in-market Large Pickup Segment competitors. Technology refers to advanced vehicle features including driver assistance systems and connectivity, safety, comfort, and convenience features. See Owner's Manual for safety information. Base models compared. Based on manufacturer websites. <sup>6</sup>Maximum towing capacity when properly equipped. Maximum towing of up to 10,920 lbs. for TITAN XD® Crew Cab 4x4. Towing capacity varies by configuration. See Nissan Towing Guide and Owner's Manual for additional information. <sup>7</sup>Maximum towing of up to: 9,310 lbs. for TITAN® Crew Cab 4x2; 9,200 lbs. for TITAN® Crew Cab 4x4; 9,320 lbs. for TITAN® King Cab® 4x2; 9,200 lbs. for TITAN® King Cab® 4x4. Towing capacity varies by configuration. See Nissan Towing Guide and Owner's Manual for additional information. <sup>8</sup>Maximum Crew Cab towing capacity up to 11,060 lbs. when using available gooseneck hitch. Gooseneck hitch available on Convenience Package-equipped 2022 TITAN XD® SV or PRO-4X® models or higher. Up to 10,920 lbs. maximum towing capacity for 2022 TITAN XD® when using standard tow hitch receiver. Towing capacity varies by configuration. See Nissan Towing Guide and Owner's Manual for additional information. <sup>9</sup>Nissan Safety Shield technologies can't prevent all collisions or warn in all situations. See Owner's Manual for important safety information. <sup>10</sup>Availability of features vary by vehicle model year, model, trim level, packaging, and options. Please see Owner's Manual for important feature information. <sup>11</sup>Automatic Emergency Braking with Pedestrian Detection cannot prevent all collisions and may not provide warning or braking in all conditions. Driver should monitor traffic conditions and brake as needed to prevent collisions. See Owner's Manual for safety information. <sup>12</sup>Rear Automatic Braking cannot prevent all collisions and may not provide warning or braking in all conditions. Driver should always turn and check surroundings before driving and brake as needed to prevent collisions. See Owner's Manual for safety information. <sup>13</sup>Rear Cross Traffic Alert may not detect all vehicles. See Owner's Manual for safety information. <sup>14</sup>Blind Spot Warning cannot prevent collisions and may not detect every object or warn in all situations. Driver should always turn and look before changing lanes. See Owner's Manual for safety information. <sup>15</sup>Lane Departure Warning operates only when lane markings are able to be detected. See Owner's Manual for safety information. <sup>16</sup>Driving is serious business and requires your full attention. If you have to use the connected device while driving, exercise extreme caution at all times so full attention may be given to vehicle operation. <sup>17</sup>Available feature. <sup>18</sup>Use feature only when safe and legal. Compatible device and service required. Subject to third party service availability. For more information see [NissanUSA.com/connect/legal](https://www.nissanusa.com/connect/legal). <sup>19</sup>Zero Gravity seats for outboard passengers only. <sup>20</sup>Intelligent Cruise Control uses limited braking and is not a collision avoidance or warning system. Driver should monitor traffic conditions and brake as needed to prevent collisions. See Owner's Manual for safety information. <sup>21</sup>Use Hands Free Text Messaging when parked in a safe location. If you must use while driving, monitor traffic conditions and keep both hands on the steering wheel to prevent collisions. Compatible device required. Message and data rates may apply. <sup>22</sup>Never program while driving. GPS mapping may not be detailed in all areas or reflect current road status. <sup>23</sup>Intelligent Around View® Monitor cannot eliminate blind spots and may not detect every object. Driver should always turn and check surroundings before driving. See Owner's Manual for safety information. <sup>24</sup>Virtual composite 360° view. <sup>25</sup>Towing capability varies by configuration. See Nissan Towing Guide and Owner's Manual for additional information. <sup>26</sup>Cargo shown for display purposes only. Cargo and load capacity limited by weight and distribution. Always secure cargo. Heavy loading of the vehicle with cargo, especially on the roof, will affect the handling and stability of the vehicle. <sup>27</sup>120-volt power outlet is intended only for use with compatible items. Please check specifications of wattage and amperage of items to be plugged in to determine compatibility. <sup>28</sup>Information displayed is dependent on how vehicle is equipped. Driving is serious business and requires your full attention. If you have to use the feature while driving, exercise extreme caution at all times so full attention may be given to vehicle operation. <sup>29</sup>Tire Pressure Monitoring System is not a substitute for regular tire pressure checks. See Owner's Manual for safety information. <sup>30</sup>Standard on SV 4x4 models and above. <sup>31</sup>2022 TITAN® King Cab® 4x2 not shown. <sup>32</sup>Maximum payload capacity when properly equipped. Maximum payload of up to: 1,600 lbs. for TITAN® Crew Cab 4x2; 1,650 lbs. for TITAN® Crew Cab 4x4; 1,620 lbs. for TITAN® King Cab® 4x2; 1,710 lbs. for TITAN® King Cab® 4x4. Payload capacity varies by configuration. See Nissan Towing Guide and Owner's Manual for additional information. <sup>33</sup>2022 TITAN® King Cab® 4x4 not shown. <sup>34</sup>Maximum payload capacity when properly equipped. Maximum payload of up to 2,430 lbs. for TITAN XD® Crew Cab 4x4. Payload capacity varies by configuration. See Nissan Towing Guide and Owner's Manual for additional information. <sup>35</sup>Extra cost option. <sup>36</sup>Monotone paint is available, and requires Monotone Paint Package. Gun Metallic only available with Monotone Paint Package. <sup>37</sup>Leather appointments. <sup>38</sup>Intelligent Forward Collision Warning cannot prevent collisions. See Owner's Manual for safety information. <sup>39</sup>RearView Monitor may not detect every object and does not eliminate blind spots or warn of moving objects. See Owner's Manual for safety information. <sup>40</sup>Sonar System may not detect every object. Driver should always check surroundings before driving. See Owner's Manual for safety information. <sup>41</sup>Intelligent Driver Alertness cannot provide a warning in every situation. See Owner's Manual for safety information. <sup>42</sup>Vehicle Dynamic Control cannot prevent collisions due to abrupt steering, carelessness, or dangerous driving techniques. It should remain on when driving, except when freeing the vehicle from mud or snow. See Owner's Manual for safety information. <sup>43</sup>Rear Door Alert System does not detect people or cargo. Always check rear seat before exiting. See Owner's Manual for safety information. <sup>44</sup>Traffic Sign Recognition may not detect and read all traffic signs in all conditions. Driver should monitor all traffic signs and obey all traffic laws. See Owner's Manual for details. <sup>45</sup>Remote Engine Start System to be used only in accordance with any laws or rules in effect in your vehicle's location. <sup>46</sup>Genuine Nissan Accessories are covered by Nissan's Limited Warranty on Genuine Nissan Replacement Parts, Genuine NISMO® S-Tune Parts, and Genuine Nissan Accessories for the longer of 12 months/12,000 miles (whichever occurs first) or the remaining period under the 5-year/100,000-mile (whichever occurs first) Nissan New Vehicle Limited Warranty. Terms and conditions apply. See Warranty Information Booklet for details. <sup>47</sup>Not a genuine Nissan part/accessory. Not warranted by Nissan. Refer to product manufacturer for warranty details. Nissan Limited Warranty does not cover damages or failures to the vehicle caused by improper installation or alterations of any Nissan approved accessory or component. Contact your dealer/retailer for details. <sup>48</sup>Virtual Key to be used only in accordance with any laws or rules in effect in your vehicle's location. <sup>49</sup>Brake Assist cannot prevent all collisions and may not provide warning or braking in all conditions. Driver should monitor traffic conditions and brake as needed to prevent collisions. See Owner's Manual for safety information. <sup>50</sup>Air bags are only a supplemental restraint system. Always wear your seat belt. Rear-facing child restraints should not be placed in the front-passenger's seat. All children 12 and under should ride in the rear seat properly secured in child restraints, booster seats, or seat belts according to their size. Air bags will only inflate in certain accidents. See Owner's Manual for safety information. <sup>51</sup>Vehicle must be on for the Easy-Fill Tire Alert to operate. <sup>52</sup>Payload varies by configuration. See Nissan Towing Guide and Owner's Manual for additional information. <sup>53</sup>Fuel economy based on targeted 2022 EPA Fuel Economy Estimates for





Sign up to get the latest on  
Nissan vehicles, news, and events.

<https://www.nissanusa.com/brochures/request-brochure.html>